

Article number: 20343660M24138KR

Description: E+G levelling foot
GN 343.6-60-M24-138-KR

Measures

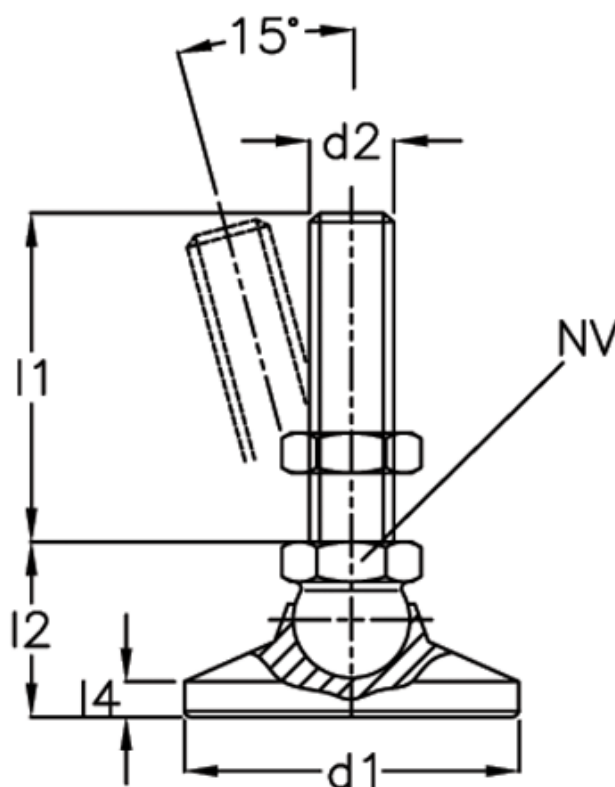

A/F	= 24
d1	= 60
d2	= 24
l1	= 138
l2	= -
l4	= -
Static load (N)	= 30
Weight in (g)	= 630